

32mm double glazed unit comprising of:  
 6mm clear toughened outer pane  
 18mm Argon filled cavity  
 8.8mm clear float laminated low 'e' inner pane

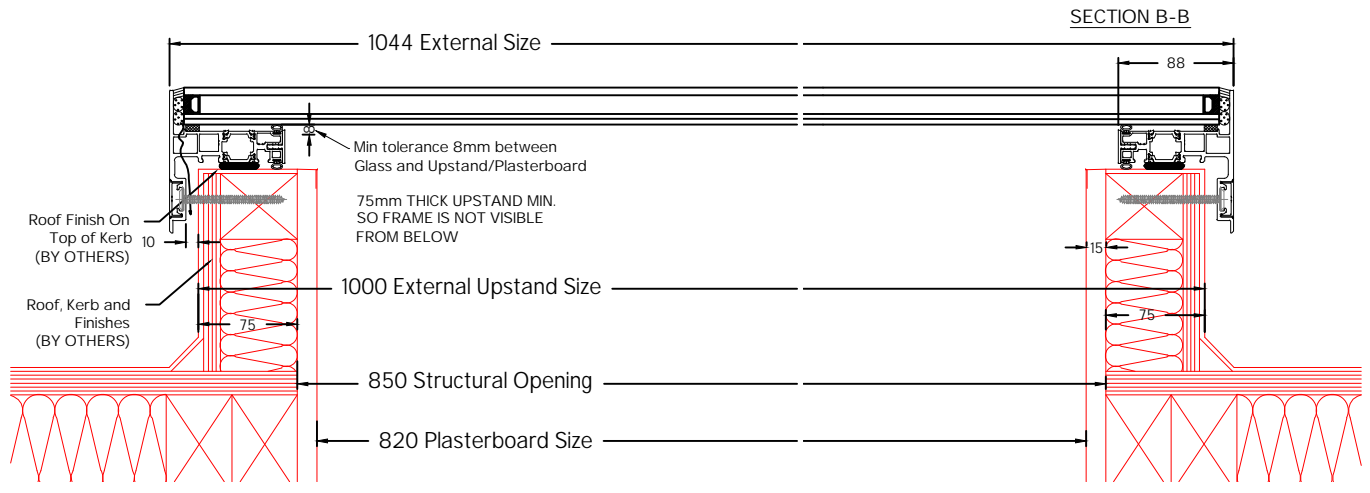

Key:  
 — by others  
 — by EOS

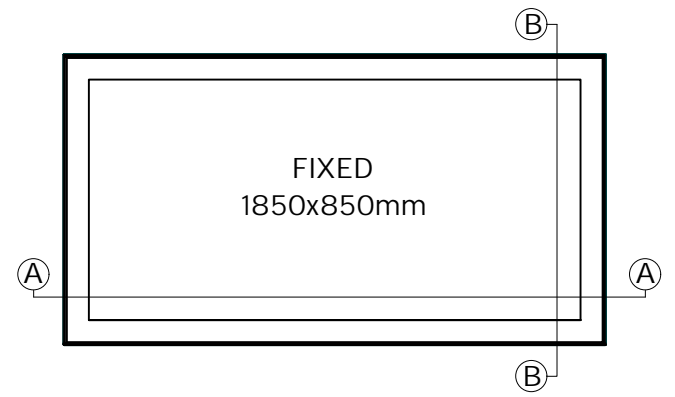
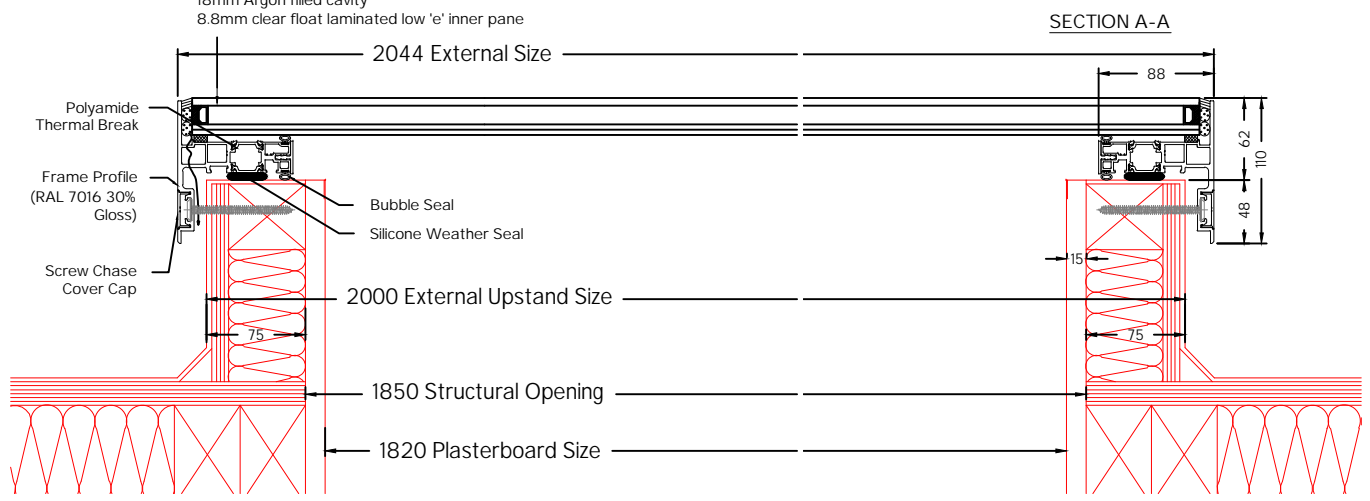
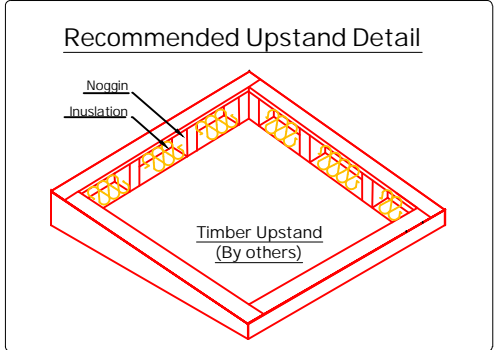

5° - 15°

Rooflight must be installed on a roof pitch between 5-15° (by others). Failure to do so will result in water pooling on the rooflight.

Title: Lite Double Glazed Fixed Rooflight - Lid Only (For Builders Upstand)			
System: Lite	Size: 1850mm x 850mm	Type: Fixed	Ref: ST33



Scale:  
1:4 @ A3

Date:  
Jan 21

0  
revision