

31mm double glazed unit comprising of:
 6mm clear toughened outer pane
 16mm Argon filled cavity
 8.8mm clear float laminated low 'e' inner pane

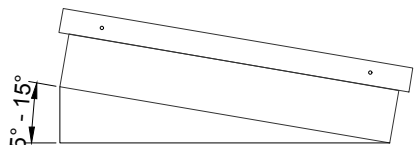

Rooflight must be installed on a roof pitch between 5-15° (by others). Failure to do so will result in water pooling on the rooflight.

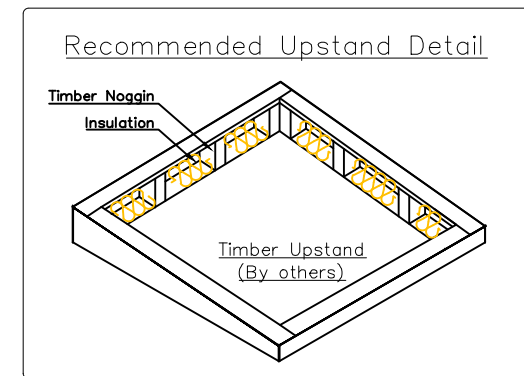
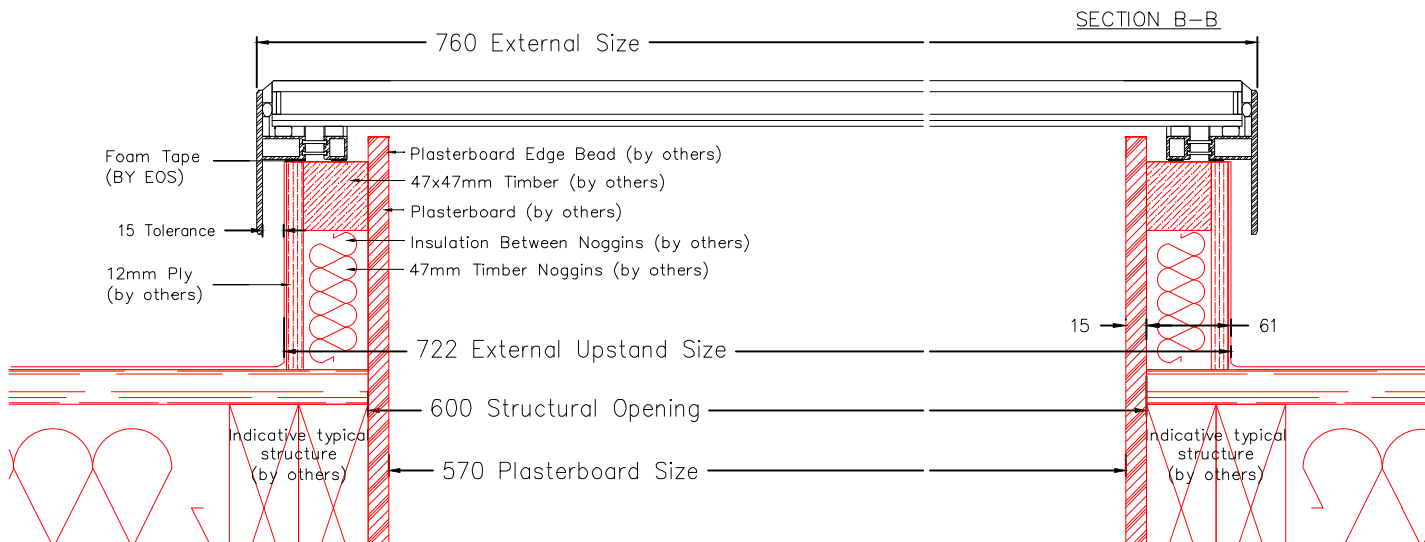
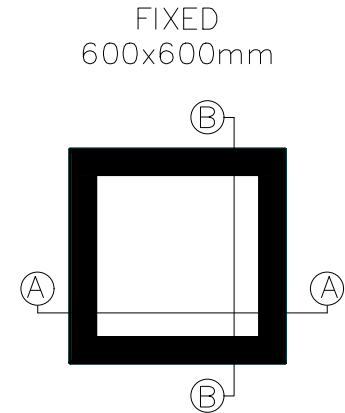
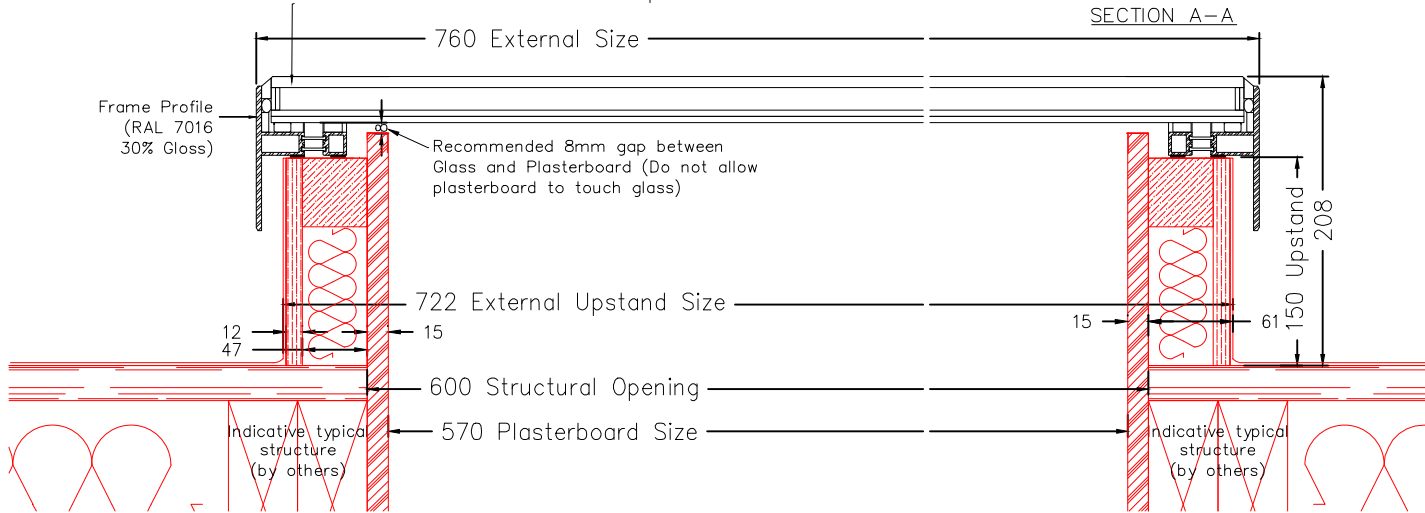

Key:
 — by others
 — by EOS



Drawing Title:
600x600mm
Fixed Rooflight

Scale:
1: 4 @ A3

Drawing No.:
F02

Date:
Feb '20

0
revision